

# DRAWINGS FOR INSTALLATION INSTRUCTION OF ELECTRIC LOCK

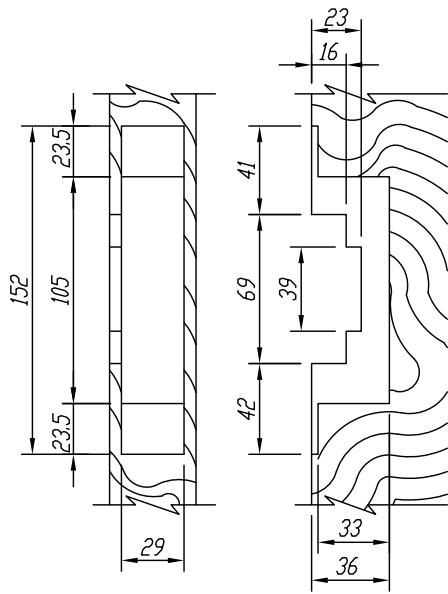

size of cutout  
(wooden door)

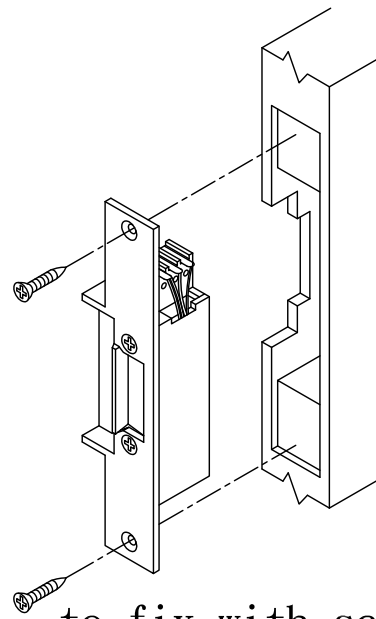

to fix with screws  
(wooden door)

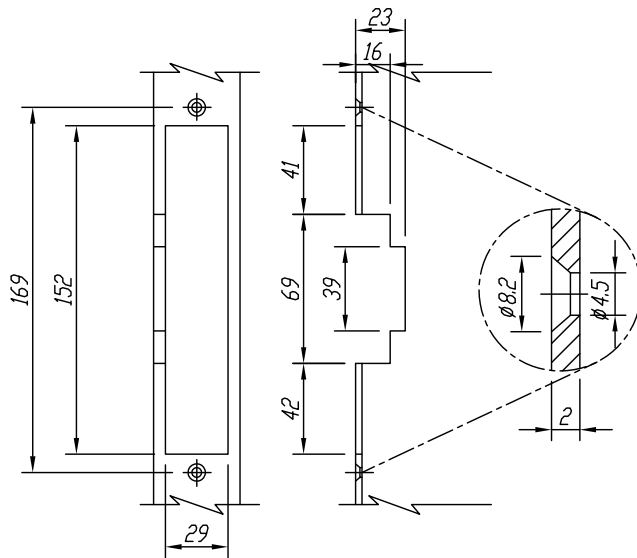

size of cutout  
(metal door)

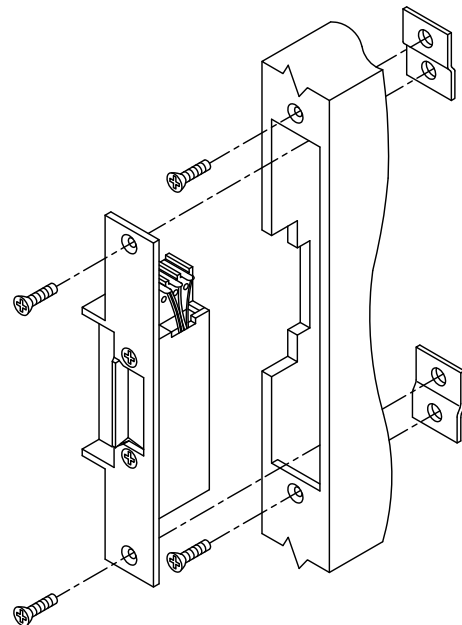

to fix with screws  
(metal door)

CIRCUIT DIAGRAM  
MODEL : EL-301A  
AC-12V DC-9V

